

DEVELOPMENT OF TOOL DETECTOR LJDOF-SDH FOR LONG JUMP AS A MEDIA FOR BASIC MOTOR OF TRACK AND FIELD LEARNING BASED ON SENSOR

by Dapan Dapan

Submission date: 13-Mar-2019 11:25AM (UTC+0700)

Submission ID: 1092466694

File name: C_7_Proceedings_YISHPESS_2017_-_Sriawan2.pdf (4.17M)

Word count: 8952

Character count: 47703



PROCEEDINGS

THE 1ST YOGYAKARTA INTERNATIONAL SEMINAR ON HEALTH, PHYSICAL EDUCATION, AND SPORTS SCIENCE.

Evidence-Based Practice of Sports Science in Education, Performance, and Health.

October 14th, 2017. Eastparc Yogyakarta, Indonesia



Published by
Faculty of Sport Sciences
Universitas Negeri Yogyakarta



FAKULTAS ILMU KEDIDIRIAAN
UNIVERSITAS NEGERI YOGYAKARTA
1 OKTOBER 1951 - 1 OKTOBER 2017

For Further Information:

Universitas Negeri Yogyakarta, Indonesia
Phone : +62274 550826 (PR Office)
Mobile : +62857 2932 3727 (Mr. Satya)
 +62815 786 0803 (Mrs. Cerika)
Email : yishpess@uny.ac.id
Website : yishpess.uny.ac.id



UNIVERSITÄT PADERBORN
Die Universität der Informationsgesellschaft



九州大学
KYUSHU UNIVERSITY



UNIVERSITI
PENDIDIKAN
SULTAN IDRIS



Chulalongkorn University
จุฬาลงกรณ์มหาวิทยาลัย

YISHPSS PROCEEDINGS

8 THE 1ST YOGYAKARTA INTERNATIONAL SEMINAR ON HEALTH, PHYSICAL EDUCATION, AND SPORTS SCIENCE. *Evidence-Based Practice of Sports Science in Education, Performance, and Health.*

Publisher

Faculty of Sport Sciences
Universitas Negeri Yogyakarta

Reviewer

Asc. Prof. Kenji Masumoto, Ph.D.	<i>(Kyushu University, Japan)</i>
Asst. Prof. Wanchai Boonrod, Ph.D.	<i>(Chulalongkorn University, Thailand)</i>
Profesor Madya Dr. Ahmad bin Hashim	<i>(Universiti Pendidikan Sultan Idris, Malaysia)</i>
Prof. Dr. Siswantoyo, M.Kes., AIFO.	<i>(Universitas Negeri Yogyakarta, Indonesia)</i>
Prof. Dr. Tomoliyus, M.S.	<i>(Universitas Negeri Yogyakarta, Indonesia)</i>
Dr. dr. B.M. Wara Kushartanti, M.S.	<i>(Universitas Negeri Yogyakarta, Indonesia)</i>
Dr. dr. Rachmah Laksmi Ambardini, M.Kes.	<i>(Universitas Negeri Yogyakarta, Indonesia)</i>
Caly Setiawan, Ph.D.	<i>(Universitas Negeri Yogyakarta, Indonesia)</i>
dr. Angelica Anggunadi, Sp.KO.	<i>(Universitas Indonesia, Indonesia)</i>
dr. Alvin Wiharja	<i>(Indonesia Sports Medicine Centre)</i>

Editor

Saryono, M.Or.	<i>(Universitas Negeri Yogyakarta, Indonesia)</i>
dr. Muhammad Ikhwan Zein, Sp. KO.	<i>(Universitas Negeri Yogyakarta, Indonesia)</i>
Nur Sita Utami, M.Or.	<i>(Universitas Negeri Yogyakarta, Indonesia)</i>
Fitria Dwi Andriyani, M.Or.	<i>(Universitas Negeri Yogyakarta, Indonesia)</i>

Editor Pelaksana

Pasca Tri Kaloka, M.Pd.	<i>(Universitas Negeri Yogyakarta, Indonesia)</i>
Krisnanda Dwi Apriyanto, M.Kes.	<i>(Universitas Negeri Yogyakarta, Indonesia)</i>
Duwi Kurnianto Pambudi, M.Or.	<i>(Universitas Negeri Yogyakarta, Indonesia)</i>
Risti Nurfadhilah, M.Or.	<i>(Universitas Negeri Yogyakarta, Indonesia)</i>
Ranintya Meikahani, M.Pd.	<i>(Universitas Negeri Yogyakarta, Indonesia)</i>

Design & Lay Out

Sugeng Setia Nugroho, A.Md.	<i>(Universitas Negeri Yogyakarta, Indonesia)</i>
-----------------------------	---

6

The paper published in the proceeding is not necessarily a reflection of the attitude or opinion of the editor and executive, editor, expert editors and the responsibility for the contents or effect of the writing, still lies on the author.

**Article published in the proceeding is considered valid
by the certificate included in the presentation.**



Published by
Faculty of Sport Sciences
Universitas Negeri Yogyakarta



Secretariat:

Universitas Negeri Yogyakarta, Indonesia
Phone : +62274 550826 (PR Office)
Mobile : +62857 2000 3727 (Mr. Satya)
+62815 7000 0803 (Mrs. Cerika)
Email : yishpess@uny.ac.id
Website : yishpess.uny.ac.id



PROCEEDINGS

THE 1ST YOGYAKARTA INTERNATIONAL SEMINAR ON HEALTH, PHYSICAL EDUCATION, AND SPORTS SCIENCE.

Evidence-Based Practice of Sports Science in Education, Performance, and Health.

October 14th, 2017. Eastparc Yogyakarta, Indonesia



Published by:
Faculty of Sport Sciences
Universitas Negeri Yogyakarta
October 14th, 2017

OPENING SPEECH

As the Dean of Faculty of Sport Sciences Universitas Negeri Yogyakarta, I would like to welcome and congratulate to all speakers and participants of the First Yogyakarta International Seminar on Health, Physical Education, and Sport Science (YISHPESS) 2017 entitled "Evidence-Based Practice of Sport Science in Education, Performance, and Health".

This international seminar is actually an implementation in the framework of the assessment of the achievements and sports culture in society that can support the achievements of the Indonesian people, so that there will be a significant role of practitioners, academicians, sport people, and sports observers from Universities, Institutions and Sports Organizations to help actively facilitate in the development, assessment of innovative sports science development so as to achieve sport achievements at the National and International level.

Finally, we thank all the committee of YISHPESS for their hard work in organizing this activity, and congratulate the invited speakers and all participants. Hopefully, this seminar is significant for the development of physical education, health, and sports sciences.



Dean of Faculty of Sport Sciences,
Universitas Negeri Yogyakarta

Prof. Dr. Wawan S. Suherman, M.Ed.

PREFACE

Alhamdulillahirobilalamin, thank Allah the First Yogyakarta International Seminar on Health, Physical Education, and Sport Science (YISHPESS) has been prepared well and on time. With all humility, we welcome and congratulate the speakers and participants of Yogyakarta International Seminar on Health, Physical Education, and Sport Science (YISHPESS) organized by the Faculty of Sport Sciences, Universitas Negeri Yogyakarta.

The YISHPESS 2017 is designed to updating and applying evidence-based practice in sports science aspects, including: education, performance and health. We hope that the invited speakers of this seminar can reduce the gaps between academic and field to get best output in the daily sport and health practices.

We would like to thank to Rector and the board of Universitas Negeri Yogyakarta for supporting this seminar come true. Praise and be grateful to the Lord, so that this proceeding can be issued. Hopefully, the publication of this proceeding can bring benefits to the participants in particular and readers in general.

Yogyakarta, October 14th, 2017
Chairperson of the Committee



Mansur
Dr. Or. Mansur, M.S.

CONTENT

Preface

Content

Keynote Speaker

- 1.THE STRUGGLE OF JERRY LOLOWANG: A CASE STUDY OF CANCER SURVIVOR IN ACHIEVING** 76
Author: M. Erika Rachman
Universitas Sebelas Maret
- 2.PHYSIOLOGICAL PROFILE OF MEMBERS HATHA YOGA EXERCISE** 83
Author: Galih Yoga Santiko
Universitas Negeri Yogyakarta
- 3.THE EFFECT OF INTERACTIVE VIDEO IN TEACHING VOLLEY BALL THROUGH BASIC PASSING TECHNIQUE** 91
Author: Rekha Ratri Julianti
Universitas Singaperbangsa Karawang
- 4.THE EFFECT OF DOMINANT PHYSICAL COMPONENTS, AND SELF-BASKET PLEEMBAN ATLET PALEMBANG TOWN SUCCESS FREE THROW** 98
Author: Bayu Hardiyono
Universitas Binadarma
- 5. DIFFERENCES IN FUTSAL SKILL BETWEEN CLUB AND HIGH SCHOOL PLAYERS** 105
Author: Agus Susworo Dwi Marhaendro
Universitas Negeri Yogyakarta
- 6. DEVELOPMENT OF INTEGRATED PHYSICAL EDUCATION LEARNING MODEL** 111
Author: Sri Winarni
Universitas Negeri Yogyakarta
- 8 THE EFFECT OF BLOCK PRACTICE, SERIAL PRACTICE AND RANDOM PRACTICE TO IMPROVE BASKETBALL FUNDAMENTAL SKILL FOR BEGINNER** 123
Author: Riyan Pratama
Universitas Bina Darma
- 17 THE DIFFERENCES OF INTRUCTIONAL MEDIA AND COORDINATION IN LEARNING OUTCOMES OF GROUNDSTROKES TENNIS ON NOVICE LEVEL ATHLETES** 131
Author: Dian Pujianto
Universitas Bengkulu
- 9. ANDROID BASED REFERENCE MODEL OF STUDENT'S SKILL COACHING** 139
Author: Endang Rini Sukamti
Universitas Negeri Yogyakarta

10. TEACHING BADMINTON SMASH BY USING TEAM GAME TOURNAMENT (TGT) MODEL IN SMP MUHAMMADYAH KARAWANG	145
Author: Didik Fauzi Dermawan Universities Singaperbangsa Karawang	
11. EFFECT OF INTENSIVE AND EXTENSIVE INTERVAL METHODS AGAINST ENHANCED SPEED ENDURANCE SPRINT 400 METERS	153
Author: Fajar Adi Nugroho Universitas Pendidikan Indonesia	
12. THE ATTEMPT OF IMPROVING POWERFUL KICK IN SOCCER USING WEIGHT TRAINING	161
Author: Yanuar Dhuma Ardhiyanto Universitas Negeri Yogyakarta	
13. IMPROVING STUDENTS LEARNING ACHIEVEMENT IN RUNNING BASIC LOCOMOTION MOVEMENT THROUGH GAME AT FIFTH GRADE STUDENT OF SD NEGERI 1 SURAKARTA IN THE ACADEMIC YEAR 2013/2014	167
Author: Luli Pitakasari Arnenda Universitas Sebelas Maret Surakarta	
14. THE INFLUENCE OF EXERCISE ON HOW TO THROW SOFTBALL BY USING THE TARGET TOWARDS THE ACCURACY OF THROWING SOFTBALL IN BUFFALOES UNS ATHELETE IN 2012	174
Author: Kristanto Adi Nugroho Universitas Sebelas Maret Surakarta	
15. MANAGEMENT OF DEVELOPING SWIMMING ACHIEVEMENT IN NPC (NATIONAL PARALYMPIC COMMITTEE) OF INDONESIA	181
Author: Nonik Rahmawati Universitas Sebelas Maret Surakarta	
16. CORRELATION OF BODY MASS INDEX AND CARDIORESPIRATORY FITNESS TO THE RISK OF METABOLIC SYNDROME IN ADOLESCENTS	189
Author: Abdullah Al-Hazmy Universitas Sebelas Maret Surakarta	
17. SOLO LAST FRIDAY RIDE AS A SPORT COMMUNITY IN SOLO	190
Author: Rianto Ardi Nugroho Universitas Sebelas Maret Surakarta	
18. DEVELOPING SNAKE LEADERS GAME FOR LEARNING MEDIA OF PHYSICAL EDUCATION SPORT AND HEALTH TO FOURTH GRADE STUDENTS OF MADANI ELEMENTARY SCHOOL IN PALU CITY	195
Author: Marhadi Universitas Tadulako	

19. THE EFFECT OF PLYOMETRICS TRAINING AND ACHIEVEMENT MOTIVATION TOWARDS LEG MUSCLE EXPLOSIVE POWER OF VOLLEYBALL ATHLETES IN UNIVERSITAS NEGERI PADANG	205
Author: Muhamad Sazeli Rifki Universitas Negeri Padang	
20. THE PSYCHOLOGICAL CHARACTERISTICS OF INDONESIAN SEA GAMES ATHLETES IN 2017 VIEWED FROM SPORT MARTIAL ARTS AND ACCURACY	210
Author: Bintara Universitas Negeri Yogyakarta	
21. EXPECTATION APPRECIATION AND PUBLIC PERCEPTION TO THE PHENOMENON OF STREETWORKOUT COMMUNITY	216
Author: Hari Hanggoro Universitas Sebelas Maret	
22. DEVELOPING OF TRADITIONAL GAMES AS NATION CULTURE THROUGH IN PHYSICAL EDUCATION LEARNING FOR ELEMENTARY SCHOOL STUDENTS	221
Author: Asriansyah Universitas PGRI Palembang	
23. CONTRIBUTION OF FLEXIBILITY, STRENGTH, AND BALANCE ON THE CARTWHEEL OF PKO STUDENTS CLASS 2016	229
Author: Ratna Budiarti Universitas Negeri Yogyakarta	
24. EFFECT SHORT-TERM AQUAROBIC EXERCISE ON DHEA-S LEVELS IN WOMEN	239
Author: Siti Baitul Mukarromah Universitas Negeri Semarang,	
25. PREDICTION OF THE INCIDENCE RATE OF CARDIOVASCULAR DISEASE FOR THE EMPLOYEES AND LECTURERS OF YOGYAKARTA STATE UNIVERSITY BASED ON THE POST-EXERCISE RECOVERY HEART RATE	240
Author: Cerika Rismayanthi Universitas Negeri Yogyakarta	
26. EFFECTIVENESS OF UMAC-CPF EXERCISE MODEL ON MOTOR ABILITY OF INDONESIAN CP FOOTBALL PLAYERS	247
Author: Fadilah Umar Universitas Sebelas Maret	
27. DEVELOPMENT OF WEB-BASED TRACER STUDY AT THE DEPARTMENT OF SPORTS COACHING EDUCATION	256
Author: Subagyo Irianto Universitas Negeri Yogyakarta	

- 14**
28. MOUNTAINEERING ACTIVITIES OF MERBABU AS SPORTS RECREATION SOCIETY (PHENOMENOLOGY STUDY ABOUT SOCIETY CONDUCTING ACTIVITIES OF MOUNTAINEERING IN THE MOUNT MERBABU NATIONAL PARK) 261
 Author: Faisal Adam Rahman
 Universitas Sebelas Maret
- 3**
29. INCREASE VO₂MAX BADMINTON ATHLETES USE EXERCISES FOOTWORK WITH METHOD HIIT (HIGH INTENSITY INTERVAL TRAINING) 265
 Author: Donie
 Universitas Negeri Padang
- 30. THE EFFECT OF EXERCISE MODEL BASED ON INTERACTIVE MULTIMEDIA TO SEPAKTAKRAW SKILLS** 270
 Author: Didik Purwanto
 Universitas Tadulako
- 31. SOCCER TRAINING MODEL IN YOUTH ATHLETE BASED ON THE LONG-TERM ATHLETE DEVELOPMENT (LTAD)** 275
 Author: Komarudin
 Universitas Negeri Yogyakarta
- 32. LEARNING RESULTS IMPROVEMENT OF FOREARM PASSING RESULTS OF VOLLEY BALL GAME THROUGH DRILL METHODS ON STUDENTS XI.IPS.1 IN PUBLIC SENIOR HIGH SCHOOL I TELAGASARI KARAWANG** 280
 Author: Akhmad Dimiyati
 UNSIKA
- 33. PHYSICAL EDUCATION AND SPORT IN SCHOOLS: APPLICATION SOCCER LIKE GAMES** 292
 Author: Mochamad Ridwan
 Universitas Negeri Surabaya
- 34. THE DIFFERENCES OF PHYSICAL FITNESS LEVELS BETWEEN POOR AND EXCESSIVE NUTRITIONAL STATUS** 297
 Author: Sepriadi
 Universitas Negeri Padang
- 35. THE STUDY OF KNOWLEDGE ABOUT FIRST AID (P3K) AND BASIC LIFE SUPPORT PRINCIPLES IN YOGYAKARTA COMMUNITY** 305
 Author: Eka Novita Indra
 Universitas Negeri Yogyakarta
- 36. THE INFLUENCE OF TEACHING STYLE AND MOTOR ABILITY ON THE BOTTOM PASSING LEARNING OUTCOMES IN THE VOLLEYBALL** 314
 Author: Ahmad Muchlisin Natas Pasaribu
 Universitas Muhammadiyah Tangerang

37. EFFECTIVENESS OF SHOOTING TRAINING MODEL FEBI FUTSAL GAMES ON THE IMPROVEMENT OF SHOOTING RESULT ON FUTSAL SPORTS FOR BEGIN PLAYER	321
Author: Febi Kurniawan Universitas Singaperbangsa	
38. DIFFERENCES OF LEARNING ACHIEVEMENTS INTERGRADE AND GENERAL CLASS SPORT CLASS BASED ON LEVEL EDUCATION OF PARENTS IN CLASS VII SMP N 4 PURBALINGGA	327
Author: Audi Akid Hibatulloh Universitas Negeri Yogyakarta	
39. LEARNING MODELS OF PHYSICAL ACTIVITY BASED ON MOTOR PERCEPTION KINDERGARTEN STUDENT	334
Author: B.Suhartini Universitas Negeri Yogyakarta	
40. DESIGN OF MEASURABLE SPORTS CLUB IN ELEMENTARY SCHOOL IN BALI PROVINCE	341
Author: Suratmin Universitas Pendidikan Ganesha	
41. ANALYSIS OF PHYSICAL CONDITION OF SOCCER ATHLETE'S PORDA OF BEKASI CITY	348
Author: Apta Mylsidayu Universitas Islam 45 Bekasi	
42. HEALTH AND HEALTHY LIFESTYLE ENHANCEMENT THROUGH SPORT AND PHYSICAL EDUCATION CREATIVE APPROACH	356
Author: Wing Prasetya Kurniawan Universitas Nusantara PGRI Kediri	
43. THE EFFECTS OF PHYSICAL EXERCISE THROUGH GAME-MODEL AND CIRCUIT-MODEL EXERCISES APPROACH ON THE MAXIMUM AEROBIC CAPACITY	367
Author: Umar Universitas Negeri Padang	
44. DIFFERENCES INFLUENCE OF INTERVAL DRILL EXERCISE BETWEEN ACTIVE AND PASSIVE ON SKILLS OF ATHLETE AT THE AGE OF CHILDREN	377
Author: Hariyuda Anggriawan Universitas Sebelas Maret	
45. EXERCISE FOR CHILDREN WITH AUTISM SPECTRUM DISORDERS	383
Author: Anita Suryani Universitas Indonesia	

- 46. THE EFFECT OF KICKING SPEED, STRENGTH AND LEG MUSCLE EXPLOSIVE POWER ON THE ABILITY OF DOLLYO CHAGI OF TAEKWONDO DOJANG ATHLETE** 390
Author: Nurul Ihsan
Universitas Negeri Padang
- 47. CORRELATION BETWEEN PROTEIN INTAKE WITH MUSCLE STRENGTH OF ATHLETES** 398
Author: Wilda Welis
Universitas Negeri Padang
- 48. DEVELOPMENT OF MONITORING BOOKS FOR SWIMMING** 404
Author: Nur Indah Pangastuti
Universitas Negeri Yogyakarta
- 49. THE DIFFERENCE IN THE EFFECTS OF BIRTH TYPES ON THE MOTOR SKILLS OF CHILDREN AT AN EARLY AGE** 411
Author: Panggung Sutapa
Universitas Negeri Yogyakarta
- 50. THE EFFECT OF SUPPLEMENT SOYBEAN MILK AND WHEY PROTEIN IN LOAD EXERCISESTOWARD THE INCREASING HYPERTROPHY OF THIGH MUSCLES** 417
Author: Khairuddin
Universitas Negeri Padang
- 51. PHYSICAL ACTIVITY OF CHILDREN IN DIENG PLATEAU BANJARNEGARA REGENCY (PHENOMENOLOGICAL STUDIES FROM THE VIEWPOINT OF SPORTS VALUES)** 424
Author: Dody Tri Iwandana
Universitas Sebelas Maret
- 52. PICTURE MEDIA DEVELOPMENT FOR PENCAK SILAT LEARNING IN HIGH SCHOOLS** 427
Author: Nur Rohmah M., M.Pd
Universitas Negeri Yogyakarta
- 53. THE EFFECT OF IMAGERY ON BEGINNER TENNIS PLAYERS' FOREHAND DRIVE SKILL** 436
Author: Risti Nurfadhila
Universitas Negeri Yogyakarta

- 54. THE EFFECT OF HONEY SUPPLEMENTATION BEFORE PHYSICAL ACTIVITY TOWARDS THE PLASMA MALONDIALDEHYDE LEVEL IN MALE WISTAR RATS (*RATTUS NORVEGICUS*)** 443
 Author: Krisnanda DA
 Universitas Negeri Yogyakarta
- 55. THE LEARNING RESULT OF FOOTBALL BASIC TECHNIQUE SKILL** 451
 Author: Arsil
 Universitas Negeri Padang
- 56. BREAKING THE CHAIN OF “KLITIH” THROUGH CHARACTER EDUCATION IN PHYSICAL EDUCATION** 458
 Author: Pasca Tri Kaloka
 Universitas Negeri Yogyakarta
- 57. PHYSICAL EDUCATION LEARNING THROUGH TRADITIONAL GAMES TO IMPROVE COOPERATION AND RESPONSIBILITY AT ELEMENTARY SCHOOL** 466
 Author: Ranintya Meikahani
 Universitas Negeri Yogyakarta
- 58. MODEL DEVELOPMENT BASIC DRIBLING FOOTBALL-BASED TRAINING TECHNIQUES FOR BEGINNING ATHLETES AGED 8-12 YEARS** 474
 Author: Ahmad Atiq
 Universitas Tanjungpura Pontianak
- 59. THE MODEL OF GAMES TO DEVELOP FUNDAMENTAL MOVEMENT OF KINDERGARTEN STUDENTS** 481
 Author: Uray Gustian
 Universitas Tanjungpura
- 60. DEVELOPMENT OF MEDIA-BASED TRAINING 3GS (TRIPLE GAME SET); MONOPOLY, SNAKES LADDERS AND FENCING PUZZLE FOR CHARACTER EDUCATION EFFORTS IN BEGINNER ATHLETES** 489
 Author: Faidillah Kurniawan
 Universitas Negeri Yogyakarta
- 61. STUDENTS’S PERCEPTION TOWARDS INTEGRATED LEARNING METHOD USING VIRTUAL MICROSCOPE IN HISTOLOGY COURSE** 498
 Author: RL Ambardini
 Universitas Negeri Yogyakarta

- 3**
- 62. THE DEVELOPMENT OF TOPURAK (TOTOK-PUKUL-GERAK) MANIPULATION MODEL FOR KNEE JOINT REPOSITION** 504
 Author: BM. Wara Kushartanti
 Universitas Negeri Yogyakarta
- 63. THE EFFECTIVENESS OF TRAINING GUIDED IMAGERY IN LOWERING ANXIETY ON ATHLETES** 511
 Author: Donie
 Universitas Negeri Padang
- 64. EFFECT OF FRESH COW MILK AND PASTEURIZATION MILK TOWARD GLUCOSE IN SOCCER PLAYERS ACCOMPANIED BY PHYSICAL ACTIVITY.** 517
 Author: Rini Syafriani
 Institut Teknologi Bandung
- 65. THE CONTRIBUTION OF LEG MUSCLE STRENGTH AND DYNAMIC BALANCE TOWARDS THE ABILITY OF DOLLYO CHAGI KICK** 524
 Author: Yogi Setiawan
 Universitas Negeri Padang
- 66. LAY UP SHOOT SKILL OF FIK UNP STUDENTS (EXPERIMENTAL STUDY OF TEACHING METHOD AND LEARNING MOTIVATION TOWARD LAY UP SHOOT SKILL OF FIK UNP STUDENTS)** 529
 Author: Hendri Neldi
 Universitas Negeri Padang
- 67. THE EFFECT OF PRACTICE AND GAME LEARNING APPROACH ON THE CHEST PASS LEARNING ACHIEVEMENT ON EXTRACURRICULAR BASKET BALL PLAYING** 536
 Author: Puthut Endiarto
 Universitas Sebelas Maret
- 20**
- 68. THE INFLUENCE OF CIRCUIT TRAINING METHOD ON THE ENHANCEMENT OF PHYSICAL FITNESS OF SPORTS EDUCATION DEPARTMENT STUDENTS** 541
 Author: Sefri Hardiansyah
 Universitas Negeri Padang
- 69. EFFECT OF PHYSICAL ACTIVITY ON OXIDATIVE STRESS: A REVIEW OF IMPACT AND IMPLICATION AFTER TRAINING** 548
 Author: Wildan Alfia Nugroho
 Universitas Sebelas Maret
- 70. SPORT DEVELOPMENT INDEX IN SEVERAL CITIES/REGENCIES IN JAVA ISLAND : A REVIEW OF BENEFITS AND OUTCOME** 554
 Author: Boy Sembaba Tarigan
 Universitas Sebelas Maret

71. THE EFFECT OF MANIPULATION TRAINING COMPLEX TO MAXIMUM STRENGTH	559
Author: Mansur Universitas Negeri Yogyakarta	
72. MANAGEMENT OF FACILITIES SPECIAL CLASS OF SPORT (KKO) IN SMA NEGERI 4 YOGYAKARTA	569
Author: Tri Ani Hastuti Universitas Negeri Yogyakarta	
73. DEVELOPMENT OF LEARNING ATHLETIC LEARNING MODELS RELEASE DIRECTLY BASED GAMES IN ELEMENTARY SCHOOL	578
Author: Hartati Universitas Sriwijaya	
74. THE EFFECT OF COOPERATIVE LEARNING MODEL OF TEAM GAMES TOURNAMENT ON LAY UP SHOOT TOWARDS THE LEARNING OUTCOMES (EXPERIMENTAL STUDY) ON BASKETBALL SMP NEGERI KARAWANG	586
Author: Rahmat Iqbal Universitas Singaperbangsa Karawang	
75. THE EFFECTS OF PRACTICE METHOD AND ACHIEVEMENT MOTIVATION ON MAXIMUM VOLUME OXYGEN OF FOOTBALL PLAYERS	594
Author: Didin Tohidin Universitas Negeri Padang	
76. THE EFFECT OF PROTEIN SUPPLEMENT ON MAXIMUM STRENGTH TOWARD THE MEMBERS OF ONE GYM FITNESS CENTER PADANG	600
Author: Adnan Fardi Universitas Negeri Padang	
77. THE EFFECT OF PACITAN SWEET ORANGE JUICE TO MALONDIALDEHYDE LEVEL (MDA) AFTER ECCENTRIC ACTIVITY	606
Author: Indra H.S Universitas Negeri Surabaya	
78. COMMUNITY INTERESTS FOLLOWING TRADITIONAL SPORT ACTIVITIES IN CAR FREE DAY ACTIVITIES	611
Author: Mia Kusumawati Universitas Islam" 45" Bekasi	
79. THE EFFECT OF TWO ACTIVE RECOVERIES IN REDUCING LACTIC ACID OF BADMINTON ATHLETES	617
Author: Ainur Rasyid PGRI Sumenep	
80. THE EFFECT OF AEROBIC DANCE AND CYCLING ON THE PSYCHOLOGICAL WELL-BEING OF TEENAGERS	623
Author: Rizki Kurniati Universitas Pembinaan Masyarakat Medan	

- 81. SURVEY OF THE LEISURE TIME ACTIVITIES OF THE STUDENTS OF FACULTY OF SPORTS SCIENCE, UNIVERSITAS NEGERI YOGYAKARTA** 632
Author: Dapan
Universitas Negeri Yogyakarta
- 15**
82. ANTROPOMETRY AND PHYSICAL FITNESS FACTORS DETERMINANT DRIBBLING AND PASSING FUTSAL ABILITY OF STUDENT EXTRACURRICULAR AGED 12-15 YEARS 637
Author: Nizamuddin Nur Ramadaniawan
Universitas Sebelas Maret
- 83. MULTI STATION REBOUNDER TOOL DEVELOPMENT AS A GUIDE FOR TRAINING INSTRUMENT BASED ON INDEPENDENT FOOTBALL** 643
Author: Santoso Nurhadi
Universitas Negeri Yogyakarta
- 84. DEVELOPMENT OF TOOL DETECTOR LJDOF-SDH FOR LONG JUMP AS A MEDIA FOR BASIC MOTOR OF TRACK AND FIELD LEARNING BASED ON SENSOR** 651
Author: Sriawan
Universitas Negeri Yogyakarta

DEVELOPMENT OF TOOL DETECTOR LJDOF-SDH FOR LONG JUMP AS A MEDIA FOR BASIC MOTOR OF TRACK AND FIELD LEARNING BASED ON SENSOR

Sriawan¹, Dapan¹, Kurniawan Faidillah¹, Prayadi HY¹

¹⁸ ¹⁸ Faculty of Sports Science, Universitas Negeri¹⁸ 1 Yogyakarta
sriawan@uny.ac.id, dapan@uny.ac.id, faidillah_fencing@uny.ac.id, heri_yogo@uny.ac.id

Abstract

Objectives: The objective of this study is development of tool detector LJDOF-SDH for long jump as a media for basic motor of track and field learning based on sensor.

Methods: In this study, researcher used the qualitative descriptive method with the secondary data for the basic principle think with the forum group discussion and forum group interview with the expert, stake holder and the student.

Results: The results of this research is a prototype of tool detector LJDOF-SDH for long jump as a media for basic motor of track and field learning based on sensor. The development of detector validation tools take off long jump based sensors as a means to validate the results take off long jump at the time of athletic basic motion learning, this validation detector tool is more effective than the previous operating tool.

Conclusion: After going through several stages of development of the operation of detector validation of the sensor-based off off by using laser sensor, this research can be concluded that is:

2 The creation of detector validais appliance take off long jump based sensor with specification:

a. CPU: ATmega328.

b. Data control: Arduino IDE

c. Sensor: ky-008.

d. Battery system: lipo 3cell 12V / 2500mah.

e. Indicator: 9G servo motor

f. Application of long jump detector

2. Product worthy to be used in terms of work system tools and equipment resistance to external disturbances such as shock resistance from the body athletes when take off.

3. Product analytical tool has been completed with guidance manual of use which have been prepared by researcher.

Keywords: Development, Long Jump, Sensor, Learning Process, Physical Education Department

INTRODUCTION

The progress of science and technology (Science and Technology) has been growing rapidly recently. This is marked by the number of new innovations emerging in various fields of science. Sports is a science that also really need assistance by the technology to support when doing such an activity.

The term "athletic" comes from the word "atlon" (greek) meaning "race" or "race". For us, athletics is a sport consisting of three race numbers, namely: street and running number, jump and throw. Americans, English and many other countries, including the region in ASEAN used the term "Track and Field", and the Dutch call the term "Atletiek" (Tamsir Riyadi, 1985: 1).

The athletic sports branch is a physical activity consisting of dynamic and harmonious basic movements, ie roads, jumps and throws (Edy Purnomo, 2007: 1). Of the four numbers are officially there are 44 events in the match in multievent activities such as PON, Sea Games and Olympics. Each number on the athletic branch has different characteristics. One of them in the long jump number of validity is determined by the judge about the validity of the jumper in making the jump.

In the long jump number there is a repulsion pedestal marked with a flat beam planted with a prefix and the surface of the landing site. This is a legitimate area for jumpers, whereas jumpers are declared invalid when touching the beam's edge closer to the landing site. The edges are

the frontier line of a plastisin indicator board mounted as a tool for the jury to see the validity of a jumper in a leap.

Please note that sometimes need carefulness and accuracy in paying attention to detail plastisin indicator board installed, so that lead to errors in declaring whether or not the results of exercise or learning especially long jump numbers. In this research the research team will add the sensor tool to minimize the error along with some counterparts as a marker of the jump result is good and correct or not that is visual and auditory and also equipped with leap recorder chip that can be transferred to computer data about quality of jump result so that later hope will greatly facilitate the lecturer pengels athletic basic motion courses in the assessment.

Perhaps this has been a concern for a long time and has been given a solution. For example, by using a video recording when jumping jumps with camera video recorder, to be able to determine the validity of a jumper. It cannot be denied, this is a good solution. However, video recorder cameras are usually used only in high-level prestice competitions, for example at the National and International levels. This is because to be able to use the video recorder camera must use a relatively expensive funds.

Based on these considerations, it is expected to develop a long jump validation detector tool that utilizes laser sensors that will be connected to sign lights, flags, data recorders of jumps that also use dual electrical system (AC-DC) and buzzer able to detect whether or not the jump results while doing repulsion as a simple solution. The smaller sensor size is easier to apply to many needs, in addition to accurate needs for the sensor also includes ease of use, sensitivity and price levels. In addition, by using AC-DC electrical technology then this tool will be very flexible to be used anywhere.

METHOD

19
This research uses research with research and development method. Research 13 and development is a research method used to produce a specific product used research that needs analysis and to test the effectiveness of these products in order to function in the wider community, it is necessary research to test the effectiveness of these products (Sugiyono, 2011: 297).

According to Sumadi Suryabrata (2013: 77) the purpose of developmental research is to investigate patterns and growth sequences and changes as a function of time. This study aims to modify the tool on plastisin board in long jump by using sensor system KY-008 Laser, where this sensor will detect whether or not a jumper in jumping at the time of learning process of athletic basic motion and operational make it easier for lecturer and student to observe and see whether or not someone is in a leap.

RESULTS

Product design

The design of this product will use Ky-008 laser sensor, arduino nano for the brain of the program and photodiode to drain the flow of electricity or light to arduino uno which will in return and become a sign.

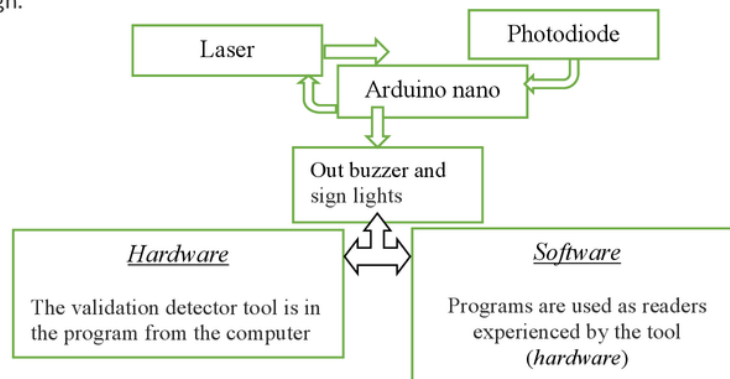

Figure 1. Technical product design flow

a. Scheme detector validation tool take off long jump based sensor

In this long jump off detection validation detector circuit, we use medium-sized electronic components so that it does not require much space to place this validation detector tool. In addition it is also calculated the function of these components in order to obtain the desired results. Therefore, the design of the tool should not be arbitrary.

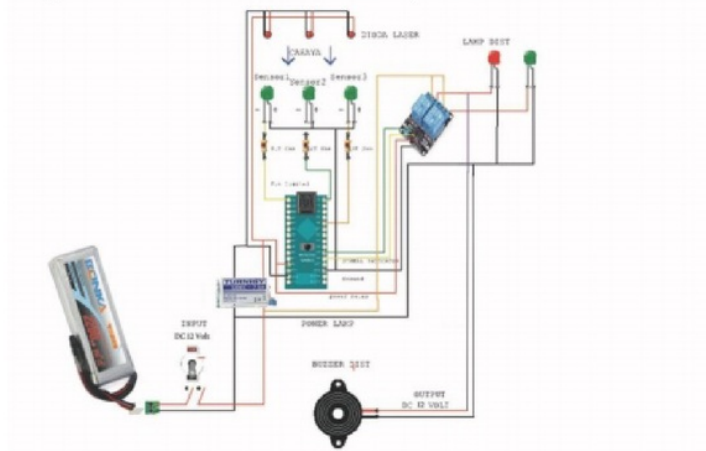

Figure 2. scheme of detector validation detection tool take off remote jump based sensor

b. Layout tool

The design of the tool should be tailored to the original purpose of manufacture. So the tool will work as expected. In addition, the physical form of the tool must also be in accordance with the place that has been in order to be easy during assembly.



Figure 3. Design flow validation tool detector

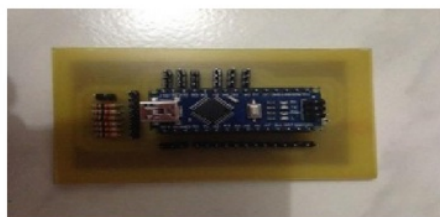

Figure 4. Physical form design of detector validation tool takes off long jump based sensor

DISCUSSION

Theory Description

1. The nature of long jump

According Mochamad Djumidar (2004: 65) jump is a movement to lift the body from a point to another point further or higher by square off run fast or slow by resting one leg and landing with the feet / other body members with a good balance. Jumps and jumps are almost the same word but have a difference between the two. Jump is done by using one foot as a pedestal while jumping using two legs as pedestal.

The long jump is the result of a horizontal velocity made from square off to the vertical motion produced from the foot of the pivot, the formulation of the feet of the two aspects was substantially derived from the foot of the pivot, the formulation of the feet of the two aspects yielded a parabolic motion force and the central point of gratification (Djumidar, 2001: 12.40). "Long jump is the simplest and simplest number compared to other field numbers. This is because students prefer to the long jump learning, this will result in students will quickly learn the long jump correctly "(Eddy Purnomo & Dapan, 2011: 93).

According Soegito, et al (1994: 60) the main elements of the sport's long jump consists of a movement run by the prefix, contrary motion, the movement of the air and ended up with the movement of the elements landing movement. Own style and contribute to results jump in the form of distance. The four movements must be performed in an unbroken series.

According Soegito, ddk (1994: 65) that must be paid attention to the teacher in keeping the far jump is:

- a. Children to keep this speed keep the running speed to take the prefix until it reaches the pivot.
- b. Use the explosive force of the foot while performing repulsion on the pivot with a fast and dynamic push.
- c. Changing slightly left position when it reaches the pivot block, intended to reach a more upright body.
- d. Use the arm compensation movement properly and appropriately.
- e. Look at the landing movements appropriately.
- f. Master the correct movement of the arms and legs in terms of straightening and bending.

The two main techniques used in long jumps are hanging techniques and kicking techniques (walking in the air). The kicking technique is more popular but both techniques have been used by elite athletes to reach more than 8.83 meters (29 feet) (Gerry A. Carr, 2003: 135).

Based on the description above, the long jump is a sport that is in desperate need of concentration and good technique movement, although the long jump is the number sport that is very simple but in the long jump, concentration and techniques is needed because if a jumper is not concentrating and taking account of measures to resist on a pedestal board, sometimes a jumper will experience a jump failure or so-called leap disqualification.

2. Long jump components

The long jump is a combined movement of the prefix, repulsion, time to float and land. The movements are repeated and between each other support so that the mastery of each movement becomes very important.

The components of the long jump component are as follows:



Figure 5. Overall motion (IAAF 2000: 35)

3. Board of support

The holder should be marked with a planted block aligned with the prefix and the surface of the landing site. The more beam edges with the rectangle are the pedestal boundary lines. Right after the boundary line has to be mounted plasticin indicator board as an aid to the jury, the construction of the pedestal should be rectangular, made of wood or other hard materials that match the length of length 1.2.2m and the width of the beam of 20 cm and the thickness of 10 cm, the beam must be white.

4. Plasticin indicator board

This board is a sturdy board with a width of 10 cm and a length of 1.22 cm made of wood or other materials suitable and should be painted in contrast to the beam, if possible the color of the

plasti should be different from the beam and indicator board. This board should be mounted on the grooves on the prefix path, just after the side of the beam nearest to the landing site. The surface should start from the surface of the support beam to a height of 7 mm. the edges shall have an edge slope and the edge closest to the prefix lane on the lid with the plastic layer extending 1 mm thick or the ends cut in such a way that the curvature when plastically filled will have a slope of a 45 ° angle.

5. Long jump detector based sensor detector component

a. Sensors

D Sharon, et al (1982), says the sensor is a device that serves to detect symptoms or signals derived from changes in energy such as electrical energy, physical energy, chemical energy, biological energy, mechanical energy and so on.

1) Characteristics of the sensor

In selecting the appropriate sensors and transducer equipment and in accordance with the system to be in the sensors it is necessary to note the following common sensor sensations.

2) Linearity Sensor

There are many sensors that produce output signals that change continuously in response to continuously changed inputs. For example, a heat sensor can generate voltage according to the heat it feels.

3) Sensitivity Sensor

Sensitivity will show how much sensor sensitivity to quantity is measured. Sensitivity is often expressed by numbers that indicate "change in output versus input change units". Some hot sensors can have a stated sensitivity with "one volt per degree", which means a one degree change in the input will result in a one volt change in the output. Other heat sensors may have a sensitivity of "two volts per degree", which means having twice the sensory of the first sensor. The sensor linearity also affects the sensitivity of the sensor. If the response is linear, then the sensitivity will also be the same for the overall measurement range. Sensors with responses to the image (b) will be more sensitive to high temperatures than low temperatures.

4) Sputter sensor time

The time response on the sensor shows how fast it responds to input changes. For example, an instrument with poor frequency response is a mercury thermometer. The input is temperature and the output is mercury position. Suppose that the temperature changes occur piecemeal and continuous with time.

b. Photodiode

Photodiode is a type of diode whose resistance varies when the light falling on the diode varies in intensity. In the dark the value of the resistance is so great that practically no current flows. The stronger the light that falls on the diode the smaller the value of resistance, so that the current flowing larger. If the photodiode of the p-n continuous-voltage connection is irradiated, the current will change linearly with the increase of the applied light flux at the junction.



Figure 6. Photodiode (ryankudeta.wordpress.com)

Photodiodes commonly used are silicon (Si) or gallium arsenide (GaAs), and others include indium antimonide (InSb), indium arsenide (InAs), lead selenide (PbSe), and tin sulfide (PBS). These materials absorb light through the characteristics of the wavelength range, for example: 250 nm to 1100 nm for silicon, and 800 nm to 2.0 μm for GaAs.

The photo diode is a type of diode that serves to detect light. Unlike the usual diode, this electronics component will convert light into electric current. Light that can be detected by this photo diode ranging from infrared light, visible light, ultra-purple to X-rays. Photo diode applications ranging from automobiles on public roadways automatically, camera light gauges as well as some medical equipment.

c. Buzzer

Buzzer Electrical is an electronic component that can convert electrical signals into vibrations of sound. In general, Buzzer which is an audio device is often used in the series of anti-theft, Alarm on Watches, House Bell, Reverse Warning on Trucks and other danger warning devices. Buzzer types are often found and used is a type of Buzzer Piezoelectric, this is because Buzzer Piezoelectric has many advantages such as cheaper, relatively lighter and easier in combining it to other Electronics Circuit.



Figure 7. Buzzer (*teknikelektronika.com*)

d. Arduino Nano

Arduino Nano is one of the microcontroller development board that is small, complete and supports the use of breadboard. Arduino Nano was created with ATmega328 microcontroller base (for Arduino Nano version 3.x) or ATmega 168 (for Arduino version 2.x). Arduino Nano more or less has the same functionality as Arduino Duemilanove, but in different packages. Arduino Nano does not include DC type Jack jacks, and is connected to a computer using a Mini-B USB port. Arduino Nano is designed and manufactured by Gravitech company.



Figure 8. Arduino nano (*illearning.me*)

Arduino Nano can be activated via a Mini-B USB connection, or through an external power supply with an unregulated voltage between 6-20 Volts connected via pin 30 or VIN pin, or via an external power supply with a 5-volt regulated voltage via pin 27 or 5V pin. The resources will be automatically selected from a higher voltage source. The FT232L FT232L chip on the Arduino Nano will be active when powered via USB, when the Arduino Nano is powered from outside (Non-USB) the FTDI Chip is off and the 3.3V pin is unavailable, while the TX and RX LEDs blinks when digital pins 0 and 1 are in HIGH position.

e. Software arduino ide

The IDE stands for Integrated Development Environment, or simply an integrated environment used for development. Referred to as the environment because through this software Arduino done programming to perform the functions embedded through the programming syntax. Arduino uses its own programming language that resembles the C language. Arduino programming language (Sketch) has been made changes to facilitate beginners in doing the programming of the original language. Prior to being sold to the market, the Arduino microcontroller IC has been embedded in a program called Bootlader that serves as a mediator between the Arduino compiler and the microcontroller.

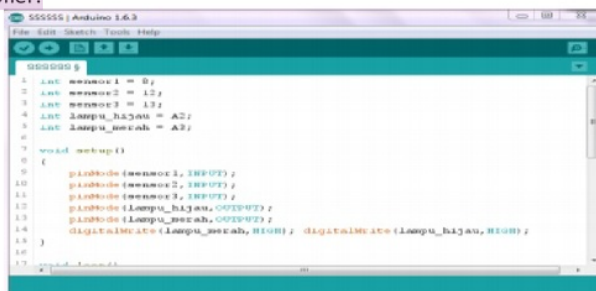

Figure 9. Software arduino ide (*sinaarduino.com*)

Programs written with the use of Arduino Software (IDE) are referred to as sketch. Sketch is written in a text editor and stored in a file with the .ino extension. The text editor of Arduino Software has features like cutting / pasting and searching / replacing that allow you to write program code.

In Arduino IDE Software, there is a kind of black message box that displays the status, such as error messages, compile, and upload the program. At the far right of the Arduino IDE Software, shows the configured board along with the COM Ports used.

f. Batre li-po 3c

Lithium Polymer Battery or commonly called with LiPo is one type of battery that is often used in the world of RC. Primarily for RC type aircraft and helicopters.

LiPo batteries do not use liquids as electrolytes but instead use dry polymer electrodes that are shaped like thin film plastic coatings. This film layer is arranged in layers between the anode and the cathode which results in ion exchange. With this method LiPo batteries can be made in various shapes and sizes. Outside of the advantages of the LiPo battery architecture, there is also a drawback of weak ion exchange ⁷ occurring via dry polymer electrolytes. This causes a decrease in charging and discharging rate. This problem can actually be overcome by heating the battery causing ion exchange to be faster, but this method is considered not to be applied to everyday circumstances. If scientists can solve this problem then the security risks in battery lithium type will be greatly reduced.



Figure 10. Batre Li-po 3S

1) Voltage

In NiCad or NiMH batteries each cell has 1.2 volts while the Lipo battery has a rating of 3.7 volts per cell. The advantage is that high battery voltage can be achieved by using fewer number of cells.

On any LiPo battery pack besides the voltage there is a label symbolized by "S". Here "S" means cell owned by a battery pack (battery pack). While numbers in front of symbols indicate the number of cells and usually range between 2-6S (although sometimes there are 10S). Here are some examples of LiPo battery notation.

- a) 3.7 volt battery = 1 cell x 3.7 volts
- b) 7.4 volt battery = 2 cells x 3.7 volts (2S)
- c) 11.1 volt battery = 3 cells x 3.7 volts (3S)
- d) 14.8 volt battery = 4 cells x 3.7 volts (4S)
- e) 18.5 volt battery = 5 cells x 3.7 volts (5S)
- f) 22.2 volt battery = 6 cells x 3.7 volts (6S)

2) Capacity

Battery capacity shows how much energy a battery can store and is indicated in ⁷ miliampere hours (mAh). This notation is another way of saying how much load can be charged to a battery for 1 hour, after which 1 hour the battery will be completely discharged.

For example a RC LiPo battery that has a 1000 mAh rating will be completely discharged if given a load of 1000 miliampere for 1 hour. If the same battery is ²¹ added 500 miliampere, then the battery will be completely discharged after for 2 hours. So even if the load is increased to 15,000 miliampere (15 Amps) then the energy in the battery akah used up after only 4 minutes. (15 Amp is the number of loads commonly used in 400 class RCs). As has been explained, with such large current

loads it is an advantage when using a battery with a larger capacity (eg 2000 mAh). That way the discharge time will increase to 8 minutes.

3) Discharge Rate

The usual discharge rate symbolized by "C" is a notation that states how fast a battery can be safely discharged. In accordance with the above explanation that the electrical energy in the LiPo battery is derived from the exchange of ions from the anode to the cathode. The faster ion exchange that can occur then means the value of "C".

A battery with a 10C discharge rate means that the battery can be discharged 10 times the actual battery capacity. so too 15C means 15 times, and 20C means 20 times. etc.

Let's use the above 1000 mAh battery example as an example. If the battery has a 10C rating then the battery can withstand a maximum load of up to 10,000 milliampere or 10 Ampere. (10 x 1000 milliampere = 10 Ampere). This figure means equal to 166 mA per minute, then the 1000 mAh battery energy will be exhausted in 6 minutes. This figure is derived calculated by calculating the amount of current per minute. 1000 mAh divided by 60 minutes = 16.6 mA per minute. Then then multiply 16.6 with the C rating (in this case 35) = 166 mA load per minute. Then divide 1000 by 166 = 6.02 minutes.

4) Internal Resistance

Internal Resistance is a number indicating the rate of resistance contained in the battery component. This resistance will determine the speed of ionization from the anode to the cathode. There are three main advantages offered by LiPo battery type batteries than other types such as NiCad or NiMH are: LiPo battery has a light weight and is available in various shapes and sizes a) LiPo battery has a large electrical energy storage capacity b) The LiPo battery has a high energy discharge rate, which is very useful in the RC field. In addition to the advantages it has, this type of battery also has several disadvantages, namely: (1) LiPo battery price is still quite expensive when compared with NiCad and NiMH batteries (2) High performance of LiPo batteries must be paid for shorter lifespan. The LiPo battery age is about 300-400 times the 31 recharge cycle. In accordance with the treatment given on the batteries. (3) Security reasons. LiPo batteries use a combustible electrolyte. (4) LiPo batteries require special handling to last a long time. Charging, Discharging, and storage can affect the age of this type of battery.

g. Ubec

Ubec 3A 5V Changing the voltage, high to low or vice versa, requires the right circuit, so that power can be delivered with the highest level of efficiency possible. Lowering the voltage by using a regulator IC like the 7805, is very commonly used. This regulator has the ability to handle currents up to 1A, with a minimum Vin equal to 7V, to produce 5V output. With a simple calculation, if Vin = 9V, then the power dissipation ~ 4 Watts, one large enough value (heat). Or, using a LDO type linear regulator, like 2940, which also has the ability to handle currents up to 1A, with a minimum Vin equal to 5.5V, to produce 5V output.



Figure 11. Ubec 3A 5V (*cristianto.tjahyadi.com*)

Another option is the switching regulator. For the need to supply a servo motor or other circuit that operates at a voltage level of 5V - 6V, it can use UBEC. UBEC - Universal Battery Elimination Circuit is an electronic circuit that takes power from a battery pack or other DC source, and lowers it to a voltage level of 5V or 6V. The maximum input voltage depends on the UBEC specification.

UBEC is usually used in applications requiring higher currents, and the device is capable of delivering power with efficiency up to 92%. When selecting UBEC, make sure the selected UBEC model has a current rating that fits the needs (load).

h. Servo Motor

Servo motor is a device or rotary actuator (motor) designed with a closed-loop feedback control system (servo), so it can be set-up or set to determine and ensure the angular position of the motor output shaft. Servo motor is a device consisting of DC motor, series of gear, control circuit and potentiometer. A series of gears attached to the DC motor shaft will slow the rotation of the shaft and increase the servo motor torque, while the potentiometer with the change of resistance when the motor rotates serves as a determinant of the rotation position of the servo motor shaft rotation. The use of a closed-loop control system on the servo motor is useful for controlling the movement and the end position of the servo motor shaft. Simple explanation like this, the position of the output shaft will be in the sensor to know the position of the shaft is exactly as desired or not, and if not, then the input control will send a control signal to make the position of the axis exactly at the desired position. For more details about closed-loop control systems, consider simple examples of some other applications of closed-loop control systems, such as setting temperature on air conditioners, refrigerators, irons and so on.

Servo motors are commonly used in industrial applications, but they are also used in many other applications such as radio controlled toy cars, robots, aircraft, and so on.



2
Figure 12. Motor servo 9g (*elektronika-dasar.web.id*)

1
There are two types of servo motors, AC and DC servo motors. AC servo motors are more able to handle high currents or heavy loads, so it is often applied to industrial machines. While DC servo motors are usually more suitable for use in smaller applications. And when distinguished by rotation, there are generally two types of servo motors that are on the market, the servo rotation motor or 180° and servo rotation continuous.

- 1) Standard servo motor (servo rotation 180°) is the most common type of servo motor, where the output spindle is limited only 90° towards the right and 90° towards the left. In other words the total round is only half circle or 180°.
- 2) Motor servo rotation continuous is a type of servo motor that is actually the same as the standard servo type, it's just the rotation of the axis without limitation or in other words can rotate continuously, either to the right or left.
- 3) The working principle of servo motor. Servo motors are controlled by providing pulse width modulation (PWM) signals via control cables. The width of the control signal pulse provided will determine the angular position of the rotation of the servo motor shaft. For example, a pulse width of 1.5 ms (milli seconds) will rotate the servo motor shaft to a 90° angle position. If the pulse is shorter than 1.5 ms it will rotate to the position 0° or to the left (counterclockwise), whereas if the pulse is given longer than 1.5 ms then the servo motor shaft will rotate toward the position 180° or to the right (clockwise). More details see the picture below.

i. Power supply

Switching power supply is a power supply design with good power efficiency. Currently electronic devices that use the adapter more and more diverse. Starting from cheap electronic equipment such as radios to mobile phones. The need for an adapter as an alternative as a battery replacement is preferred because the battery can not last long and automatically make the operational cost of an electronic device becomes larger. With an adapter no longer needed the battery but its weakness can not be carried easily because the adapter must always be connected to the PLN power grid.

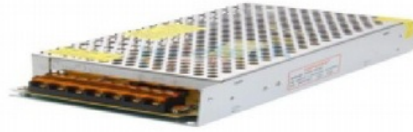

Figure 13. power supply

But even so the adapter is still used. Of the various adapter available in the market, the conventional adapter with a voltage-lowering transformer and a simple voltage regulator is more common than an adapter with switching technology.

Adapter is also known as power supply. Good supply power should be able to provide good regulatory stress and be able to provide sufficient current to the load. The unregulated voltage at the supplanted power output may cause the electronic equipment to use the power supply to be damaged, especially the voltage regulation section (if any) but if the equipment does not have an internal voltage regulation circuit then it is certain that the electronic equipment will be damaged.

j. Ftdi

The FT232RL module is a USB signal conversion module to a reliable and practical TTL / UART (USB-to-TTL Converter) signal for use in microcontroller-based electronics circuits, so your handheld electronics device can communicate with other devices via USB standard communications.

This module can be used as a USB-to-serial adapter for arduino boards that do not have on-board USB functions such as Arduino Pro Mini.

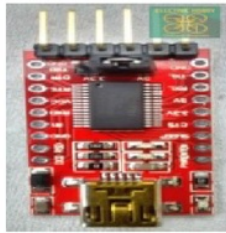

Figure 14. Ftdi

The attached USB connector is a female mini-B type connector. For Linux / MacOS / X users no driver is required to access this electronic component because the operating system will automatically recognize this USB chip and install the appropriate driver automatically.

Note: This module already includes a data connection cable, you do not need to purchase a Standard-A / Male to Mini-A / Male USB Connector Cable cable separately.

For the Windows operating system, please download the FTDI driver at the link listed below. There are two kinds of drivers, VCP (Virtual Communication Port, COMxx) that works like a regular COM port and Direct Driver (D2xx) for quick access via API (Application Programming Interface).

By default, this module works on a 5V voltage. If desired, cut the track jumper on the back of the PCB with the cutter, then connect (short) the middle pad with the 3.3V pad (see the picture on the pin configuration section below). If you often work with both levels of voltage, our electronics components store also sells FTDI-232 / DVS which has a voltage-selector jumper so there is no need to do this hacks.

k. Visual video

Visual Studio 2010 is basically a computer programming language. Where the understanding of the programming language is the commands or instructions understood by the computer to perform certain tasks.

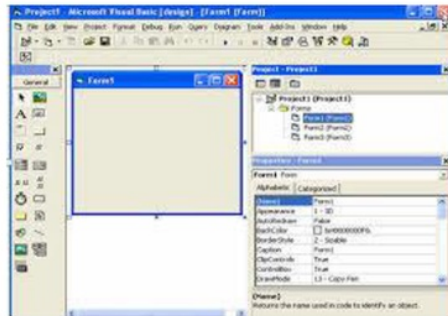

Figure 15. visual video display

Visual Studio 2010 (often referred to as VB .Net 2010) in addition to being called a programming language, is also often referred to as a tool to generate windows-based application programs. Some of the capabilities or benefits of Visual Studio 2010 include:

1. To create a windows based application program.
2. To create program helper objects such as, for example: ActiveX controls, Help files, Internet applications and so on.
3. Test the program (debugging) and generate EXE ending programs that are executable or can be directly executed.

Visual Studio 2010 is a fairly easy language to learn. For novice programmers who want to learn the program, the Visual Studio environment can help make the program in the blink of an eye. As for advanced programmers, great ability can be used to create complex programs, such as a networking environment or client server.

Visual Studio language is quite simple and uses commonly used English words. We no longer need to memorize syntax or various language formats, in Visual Basic everything is provided in the choices that are left to be taken as needed. In addition, the visual development tools make it easy for us to develop Windows-based applications, are mouse-driven and highly versatile.

A Brief History of Visual Studio 2010

Here are some important points in the history of its development:

1. First released in the name of Visual Basic issued in 1991, the Visual Basic is still based on DOS and for Windows
2. Visual Basic 3.0 was released in 1993
3. Visual Basic 4.0 was released in 1994 with support for 32 bit applications
4. Visual Basic 6.0 was released at the end of 1998
5. Visual basic for next is the .Net version released in early 2002
6. In 2003 Visual Studio 2003 was released to improve the performance of Visual Studio 2002 by launching the .NET Framework version 1.1.
7. In 2005 Microsoft issued Visual Basic Version 8.0 or commonly called Microsoft Visual Studio 2005.
8. In 2008 Microsoft also issued version 9.0 or commonly called Microsoft Visual Studio 2008.
9. Until the year 2010 Visual Studio is already in version 10.0 or commonly called Microsoft Visual Studio 2010, which in it has added a new programming language that is F # which is a refinement of previous versions.

Visual Studio Visuals 2010

Some of the features of Visual Studio 2010 include:

- Using a programming platform called studio developer, which has the same look and tools as Visual C ++ and Visual J ++. That way you can migrate or learn other programming languages easily and quickly.
- Has a powerful compiler that can generate executable files faster and more efficiently than ever before.

- Has some new wizard additions. The wizard is a tool that simplifies the creation of an application by automating certain tasks.
- Visual Studio 2010 has several features for the development of various applications including; Windows Development, Web Development, Office Development, Sharepoint Development, Cloud Development (Windows Azure), Silverlight Tooling, Multi-Core Development, Customizable IDE.

CONCLUSION

The results of the development of detector validation tools take off long jump based sensors as a means to validate the results take off long jump at the time of athletic basic motion learning, this validation detector tool is more effective than the previous operating tool. By using this laser sensor along with other supporting components then students and lecturers only need to see and validate take off on a leap. After going through several stages of development of the operation of detector validation of the sensor-based off off by using laser sensor, this research can be concluded that is:

1. The creation of detector validation appliance take off long jump based sensor with specification:
 - a. CPU: ATmega328.
 - b. Data control: Arduino IDE
 - c. Sensor: ky-008.
 - d. Battery system: lipo 3cell 12V / 2500mah.
 - e. Indicator: 9G servo motor
 - f. Application of long jump detector
2. Product worthy to be used in terms of work system tools and equipment resistance to external disturbances such as shock resistance from the body athletes when take off.
3. Product analytical tool has been completed with guidance manual of use which have been prepared by researcher.

REFERENCES

- Agus Purnama, 2013. Pengertian motor servo. <http://elektronika-dasar.web.id/motor-servo/> diunduh pada tanggal 21 mei 2017.
- Anas Sudijono, 2006. *Pengantar Evaluasi Pendidikan*. Jakarta: RA Jagrafindo Persada.
- Carr, Gerry A, 1997. *Atletik untuk sekolah*. Jakarta: Raja Grafindo Persada
- Christianto Tjahyadi, 2014. Pengertian ubec. <http://christianto.tjahyadi.com/elektronika/ubec.html> diunduh pada tanggal 11 april 2017.
- D. Sharon,dkk, 1982. *Principles of Analysis Chemistry*. New York: Harcourt Brace College Publisher.
- Djumidar, 2001. *Dasar-Dasar Atletik*, Jakarta: Depdiknas.
- Eddy Purnomo, 2006. *Dasar-Dasar Gerak Atletik*. Yogyakarta: FIK-UNY.
- Hikmat, 2017. pengertian laser. <http://klikma.com/2015/03/pengertian-laser.html> diunduh pada tanggal 5 mei 2017.
- IAAF, 2013. *Competition Rules*. Staf sekertariat IAAF. RDC Jakarta.
- IAAF, 2000. *Lari lompat lempar Level 1-Atletik*. Staf sekertariat IAAF. RDC Jakarta.
- Ipanda, 2016. Pengertian Arduino Uno. <http://illearning.me/sample-page-162/arduino/pengertian-arduino-uno/> di unduh pada tanggal 28 Desember 2016.
- Mochamad Djumidar A. Widya, 2004. *Belajar berlatih gerak-gerak dasar atletik dalam bermain*. Jakarta : PT Raja Grafindo Persada.
- Rohmadi, 2012. Pengertian modul relay. <https://rohmedi.com/2013/12/09/modul-relay-2-channel-arduino/> diunduh pada tanggal 13 mei 2017.
- Ryan Ferdy Permadi, 2012. Pengertian Photodiode. <https://ryankudeta.wordpress.com/2012/12/17/pengertian-photodiode/> di unduh pada tanggal 28 Desember 2016.
- Sinauarduino, 2016. *Pengertian software arduino ide*. <http://www.sinauarduino.com/artikel/mengenal-arduino-software-ide/> diunduh pada tanggal 11 april 2017.

- Sugito dkk, 1994. Pendidikan Atletik. Jakarta: Depdikbud. xlix
- Sugiyono, 2007. *Metode Penelitian Pendidikan Kuantitatif, Kualitatif, dan R&D*. Bandung: Alfabeta.
- Sugiyono., 2011. *Statistika Untuk Penelitian*. Bandung: Alfabeta.
- Sumandi Suryabrata, 2013. Metodologi Penelitian. Jakarta: PT RajaGrafindo Persada.
- Teknik Eletronika, 2015. Pengertian Piezoelectric Buzzer Dan Cara Kerjanya. <http://teknikelektronika.com/pengertian-piezoelectric-buzzer-cara-kerja-buzzer/> di unduh pada tanggal 28 Desember 2016.



Published by
Faculty of Sport Sciences
Universitas Negeri Yogyakarta



UNIVERSITÄT PADERBORN
Die Universität der Informationsgesellschaft



九州大学
KYUSHU UNIVERSITY



**UNIVERSITI
PENDIDIKAN
SUDAN JORJE**
The Faculty of Education



Chulalongkorn University
จุฬาลงกรณ์มหาวิทยาลัย



FAKULTAS ILMU KELAHRAGAAN
UNIVERSITAS NEGERI YOGYAKARTA
1 OKTOBER 1951 – 1 OKTOBER 2017

For Further Information:

Universitas Negeri Yogyakarta, Indonesia
Phone : +62274 550826 (PR Office)
Mobile : +62857 2932 3727 (Mr. Satya)
 +62815 7802 0803 (Mrs. Cerika)
Email : yishpess@uny.ac.id
Website : yishpess.uny.ac.id

Faculty of Sport Sciences Universitas Negeri Yogyakarta

ISBN 978-602-8429-74-0



9 786028 429740

DEVELOPMENT OF TOOL DETECTOR LJDOF-SDH FOR LONG JUMP AS A MEDIA FOR BASIC MOTOR OF TRACK AND FIELD LEARNING BASED ON SENSOR

ORIGINALITY REPORT

19%

SIMILARITY INDEX

12%

INTERNET SOURCES

4%

PUBLICATIONS

11%

STUDENT PAPERS

PRIMARY SOURCES

1	Submitted to Academic Library Consortium Student Paper	4%
2	eprints.uny.ac.id Internet Source	2%
3	Submitted to Universitas Negeri Jakarta Student Paper	2%
4	www.ajouronline.com Internet Source	2%
5	iiste.org Internet Source	1%
6	staff.uny.ac.id Internet Source	1%
7	hpisavagex46.wordpress.com Internet Source	1%
8	eprints.binadarma.ac.id Internet Source	1%

9	K U Ariawan, G S Santyadiputra, I W Sutaya. "Design of Hexapod Robot Movement Based on Arduino Mega 2560", Journal of Physics: Conference Series, 2019 Publication	1%
10	Danila Cianciosi, Tamara Forbes-Hernández, Sadia Afrin, Massimiliano Gasparrini et al. "Phenolic Compounds in Honey and Their Associated Health Benefits: A Review", Molecules, 2018 Publication	1%
11	Submitted to PSB Academy (ACP eSolutions) Student Paper	<1%
12	www.seminar.uny.ac.id Internet Source	<1%
13	Submitted to Politeknik Negeri Bandung Student Paper	<1%
14	Submitted to The University of Notre Dame Student Paper	<1%
15	ejournal.upi.edu Internet Source	<1%
16	blog.napijotett.hu Internet Source	<1%
17	journal.unj.ac.id Internet Source	<1%

18

D F Syolendra, E W Laksono. "The effect of discovery learning on students' integrated thinking abilities and creative attitudes", Journal of Physics: Conference Series, 2019

Publication

<1%

19

etheses.uin-malang.ac.id

Internet Source

<1%

20

Submitted to Universitas Negeri Padang

Student Paper

<1%

21

Submitted to Higher Education Commission Pakistan

Student Paper

<1%

22

Submitted to Universitas Negeri Semarang

Student Paper

<1%

23

www.icharger.co.nz

Internet Source

<1%

24

www.rchelicopterfun.com

Internet Source

<1%

Exclude quotes On

Exclude matches Off

Exclude bibliography On

DEVELOPMENT OF TOOL DETECTOR LJDOF-SDH FOR LONG JUMP AS A MEDIA FOR BASIC MOTOR OF TRACK AND FIELD LEARNING BASED ON SENSOR

GRADEMARK REPORT

FINAL GRADE

/0

GENERAL COMMENTS

Instructor

PAGE 1

PAGE 2

PAGE 3

PAGE 4

PAGE 5

PAGE 6

PAGE 7

PAGE 8

PAGE 9

PAGE 10

PAGE 11

PAGE 12

PAGE 13

PAGE 14

PAGE 15

PAGE 16

PAGE 17

PAGE 18

PAGE 19

PAGE 20

PAGE 21

PAGE 22

PAGE 23

PAGE 24

PAGE 25

PAGE 26

PAGE 27

PAGE 28

PAGE 29
